

# MBG



## **Sigma 105**

User Manual



**MBGSWEDEN.COM**



## User Manual

**Thank you** for choosing the Cashmaster Sigma 105 money counter. The Sigma 105 is an invaluable, easy to use, and highly accurate money counting device. The Sigma 105 is designed to manage your cash intelligently, with accuracy and efficiency. With the Sigma 105 you will speed up cash counting and reconciliation up to six times faster than by hand.

# Contents

Introduction	
Introduction.....	2
Box Items and Guidelines	
Maintenance.....	3
Warning.....	3
Charging.....	3
Guidelines	
Unpacking.....	4
Keys and Display	
Cashmaster Sigma 105.....	5
Keypad.....	6
Hod.....	6
Screen.....	6
Cashmaster Key Identification	
Key Identification.....	7
Fast Keys.....	7
Getting Started	
What can you count.....	8
Switching On.....	9
Setting the Float.....	10
Auto Add and Auto Scroll.....	11
Counting	
Coins.....	13
Learning.....	15
Notes.....	16
Totalling, Clearing, and Printing.....	17
Grams Mode.....	18
Troubleshooting.....	19
FAQ's.....	20
Technical Specification.....	22

# Introduction

---

## Introduction

The Cashmaster Sigma 105 is an electronic weighing device which calculates the value of coins and notes. The Cashmaster Sigma 105 supports your domestic currency: notes and coins. The intuitive user friendly interface guides you through the cash counting process. The Cashmaster Sigma 105 is programmed to count the contents of a typical cash register:

- Notes (loose)
- Coins (bag, roll, loose)

Using the Cashmaster you will notice some changes in the way you work:

- Reduced paperwork
- Streamlined working methods making the business more competitive
- More time to concentrate on Key Tasks

## Guidelines

1. Place the Sigma 105 on a firm, even surface, away from draughts and vibrations.
2. Insert the HOD, pushing down **VERY** firmly into position until it clicks.
3. Ensure area around the hod is kept clear.
4. The coin scoop should **NOT** be placed on the device before switching on.
5. Plug in the AC adaptor and switch on at the mains.
6. The device is not a counterfeit detector and hence will not detect counterfeit money.
7. Weights may vary from the initial factory setting. It may be necessary to carry out some initial note 'learning' in order to quickly adjust the machine to your local conditions.
8. Ensure money is sorted by denomination before counting. Mixed denominations cannot be counted.
9. Do not subject the device to strong impact or shock load by any means.
10. Ensure that money is placed onto the equipment with reasonable care.

# Box Items & Guidelines

Cashmaster Sigma 105

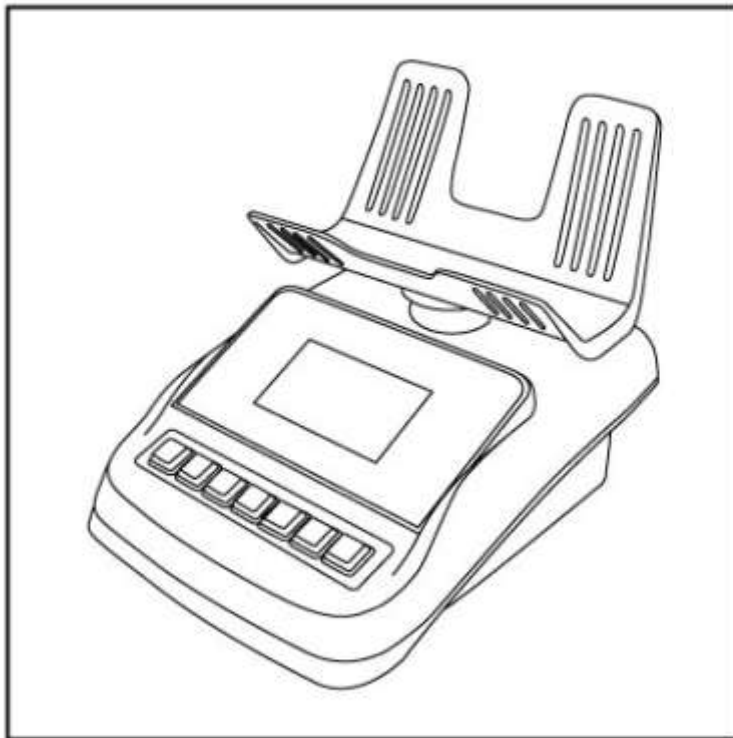

Scoop

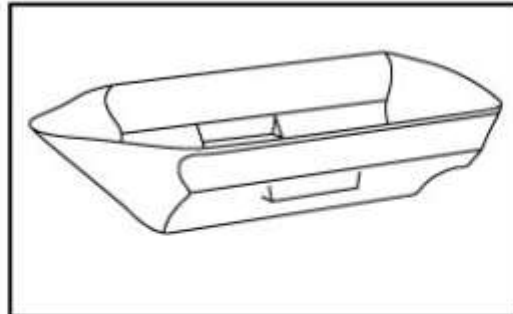

AC Adapter

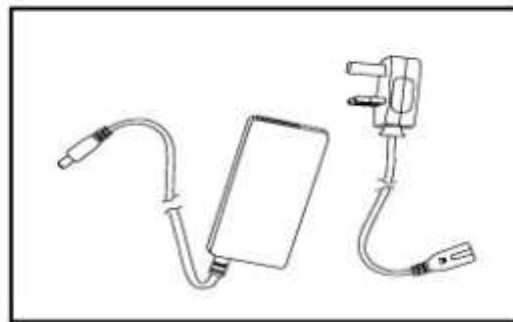

## Maintenance

Ensure power is switched off during cleaning.

Clean machine with dry cloth only. *Do not use cleaning products or damp material.*

Do not spill any liquids on device. If liquid is spilled on device, disconnect the power cable and contact your supplier.

Do not leave any objects on the Cashmaster or hod when not in use.

## Charging

Charging takes approximately 3 hours.

Only use the device with the factory supplied power adapter.

When the LED is red this indicates that the battery is fast-charging.

When the LED is green the battery is fully charged.

When the LED is flashing the battery is very low and the unit is on slow charge.

If the LED continues to flash for more than 3 hours the battery may have a fault (*in event of this, switch off the power at the mains and contact customer support*).

## Warning

Do not use a damaged or wet power adapter.

Do not connect power adapter with wet hands.

Do not place weights over 1.5kg on the device.

Do not disassemble the device, sensitive elements in the scale may be affected and this will affect your warranty.

**If any of the above are missing please contact Customer Support on  
01383 410 121 or 01383 416 098**

# Guidelines

## Unpacking

1. Unpack your Cashmaster machine and check that you have a Cashmaster scale, a hod and a power adapter.
2. Fit the hod into the top of the Cashmaster scale. Push down **very firmly** until it clicks into place.  
*(To remove the hod, hold Cashmaster machine firmly and twist the hod until it clicks, then lift the hod from the base)*
3. Plug the power adapter into the socket at the back of the Cashmaster scale.
4. Place the Cashmaster scale on a firm even surface.
5. Ensure the hod is empty (the coin scoop/till cup should NOT be placed on the hod before switching on).
6. Plug the power adapter into the power source.
7. The Cashmaster can now be operated from mains power or from battery. When the battery is low the display will show "low battery, recharge now".

Push down  
**VERY FIRMLY**  
until you hear  
a click

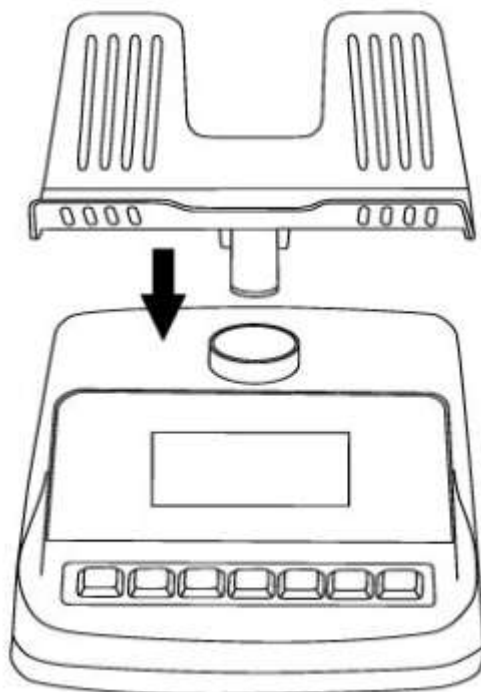

To fully charge the battery, plug the Cashmaster machine into the mains. The LED on the front will show **GREEN** (for one second) then **RED**.

(A **RED** LED indicates that the battery is charging. The charging process can take up to three hours. A **GREEN** LED indicates that the battery is fully charged and the unit is connected to the external power supply. If the LED continues to flash for more than 3 hours the battery may have a fault *(in event of this, switch off the power at the mains and contact customer support)*. No colour indicates that the unit is running on its internal battery.)

## Cashmaster Sigma 105

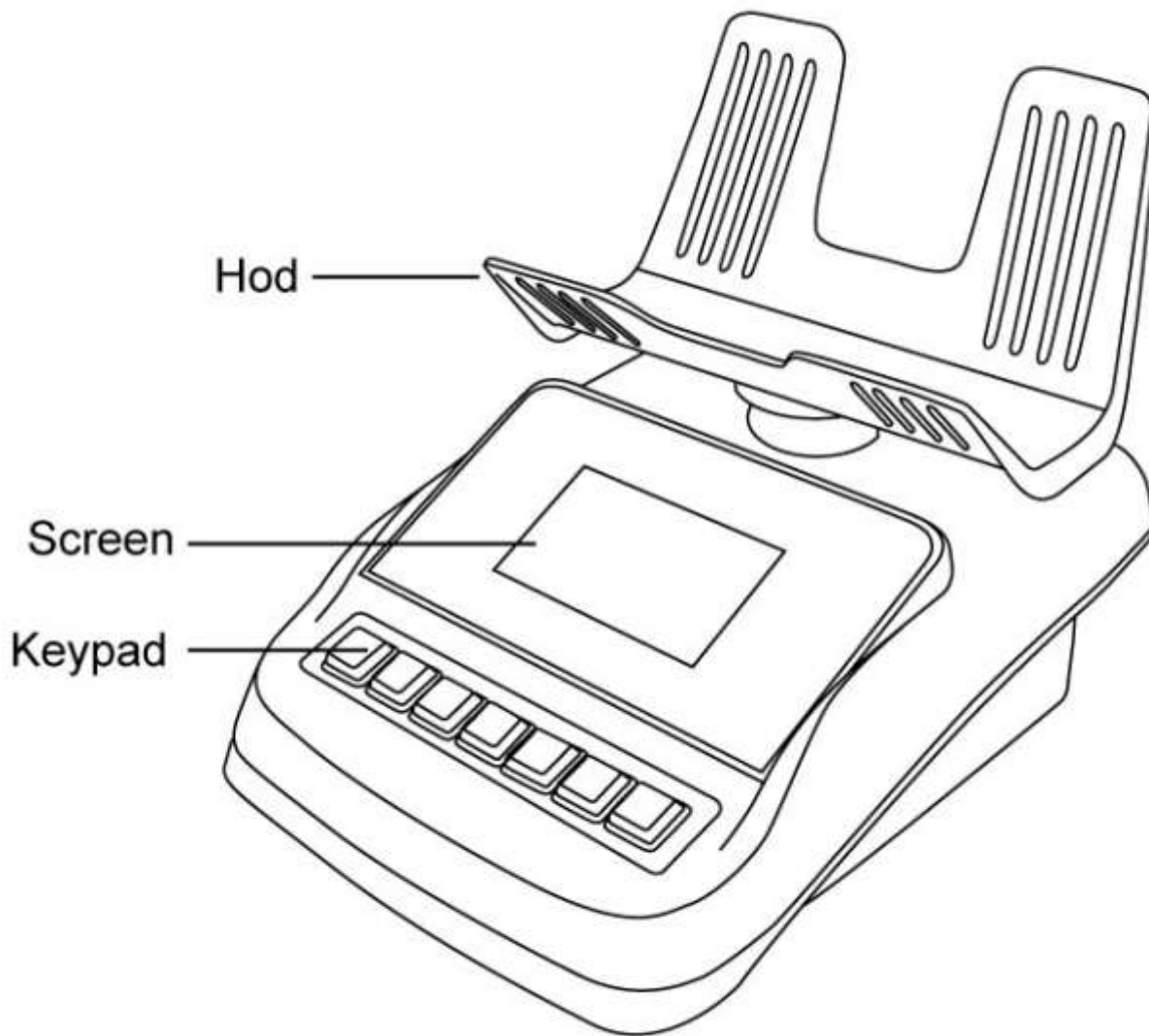

The Cashmaster Sigma 105 shown above is the device you are going to use. There are three main component parts:

- the keypad
- the screen
- the hod

The Cashmaster is robust, and will stand up to all normal Cash Office activities. Treat it with sensible care.

# Keys and Display

## The Keypad

To keep counting as easy as possible, the number and layout of the keys on the keypad has been kept simple.



The 'keys' are 'full motion' similar to those on home computers. They have their functions printed on them. They are designed to resist spills and increase durability.

## The Screen

This is where you will see:

- displays of the amounts counted
- messages related to Cashmaster functions

19.01.2009 10.15	
1c	Scoop
Coins	
EUR	0
<b>Total</b>	<b>0</b>

## The Hod

The hod is designed to hold scoops, till cups, bagged coins, rolled coins, loose notes and banded notes. To insert, place the hod on the Cashmaster and **push down very frmly**, until your hear a click.

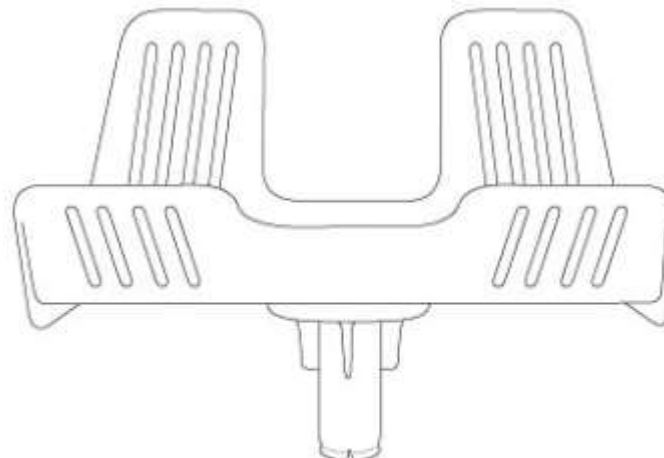



# Cashmaster Key Identification

## Key Identification



The **ON/OFF** key. Press once to switch machine on. Press and hold down to switch machine off.



The **COINS/NOTES** key. Used for selecting coins, notes or rolls.



The **C/+** key. Used for clearing values, and adding to totals.



**UP and DOWN** arrow keys. Used to toggle between up or down (through denominations).



The **PRINT** key. Press once for a print out of the totals.



The **FUNCTION** key. In combination with other keys is used to control various settings.

## Fast Keys

Fast key functions are easy access controls that allow you to quickly enter settings within the Cashmaster. More information is available on further pages. *To perform the fast key functions press both keys simultaneously.*



Set Float Limit



Auto Add on/off toggle



Float on/off toggle



Calibrate Scoop



Auto Scroll on/off toggle



Switch Currency

**Note: For assistance on any of the above please contact Customer Support on:  
01383 410 121 or 01383 416 098**



# Getting Started

## What You Can Count



### NOTES

	<p><b>Loose</b> - for counting loose notes. Loose notes are counted by placing up to 30 notes at any one time. Continue to add notes of the same denomination in quantities of up to 30, until all notes from the selected denomination have been counted.</p>
---	--

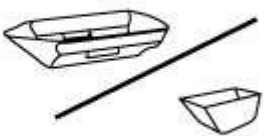
### COINS

	<p><b>Bag</b> - for counting and checking bags of coins.</p>
	<p><b>Rolls</b> - for counting and checking rolls of coins.</p>
	<p><b>Scoop or Till Cup</b> - for counting loose coins that are on a scoop or other calibrated container.</p>

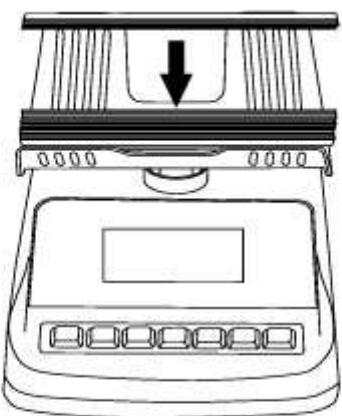
## How To Count Cash Items

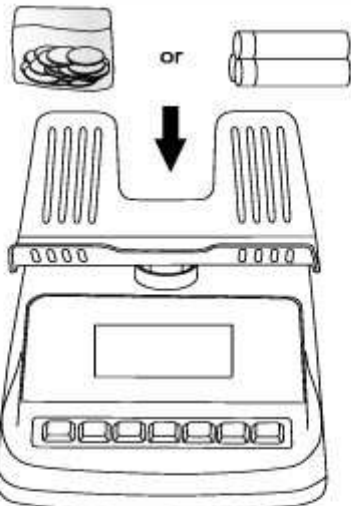
Note Counting	Coin Counting	Roll/Bag Counting
		

# Getting Started

## Switching On

Press 



When the Sigma 105 is initially switched on, the display will show the following **“Place Empty Scoop On Scale”**.

You must now place the scoop provided on top of the hod. This container is now ready to use with the machine. (Please note the scoop must only be used for counting coins).

Place Empty  
Scoop On Scale

You are now in count mode.



*To recalibrate the scoop at any time (ensure the hod is empty):*

Press  and , and follow the on screen prompt.

## Currency Setting **\*IMPORTANT\***

Please ensure your Cashmaster is set to your domestic currency. The set currency is shown above the Total/Float on the display. See table below for country and corresponding currency setting.



Country	France	Germany	Italy	Spain	Ireland	Turkey	Poland
Currency	Eur	Eur	Eur2	Eur3	Eur4	TRY	PLN

To toggle through currency options: Press both   keys at the same time, stopping at the desired currency.

# Getting Started

## Setting the Float

Press **F** and  to enter float setting.

Use  to select value position, and use   to enter the float value.



Press **F** when finished to set float.

## Switching starting float mode on/off

Once you have stored your default float amount in memory, you can switch the float mode on/off as required.

Press **F** and then  to toggle float on/off.

The display will show the current float amount stored and you may begin counting in float mode.

The float function can be switched on/off at any time.

Indicates float is on →

↑↑ 19.01.2009 10.15	
1C	Scoop
Coins	
EUR	0
Float	100.0

Indicates float is off →

↑↑ 19.01.2009 10.15	
1C	Scoop
Coins	
EUR	0
Total	0

# Getting Started

## Switching Auto-Add On/Off

Auto add is a feature that allows the Cashmaster to automatically add the value of any note/coin amount (that is placed on the hod) to the total amount.

If **Auto-Add is on**, the value displayed will be automatically added to the totals whenever the cash is placed on the hod.

If **Auto-Add is off**, the value displayed will not be automatically added to the totals, you must press  while the value is being displayed and the cash still on the hod, to add the value to the totals.

*Your device may already have Auto Add set to on/off as default. See below*

Indicates auto-add is on



The screenshot shows a teal-colored display with a black arrow pointing to a '+' sign in the top left corner. The display shows the date '19.01.2009' and time '10.15' in the top right. The main display area shows '1C' and 'Scoop' on the top line, 'Coins' on the second line, 'EUR' and '0' on the third line, and 'Total' and '0' on the bottom line.

19.01.2009	10.15
1C	Scoop
Coins	
EUR	0
Total	0

Indicates auto-add is off



The screenshot shows a teal-colored display with a black arrow pointing to a '+' sign in the top left corner. The display shows the date '19.01.2009' and time '10.15' in the top right. The main display area shows '1C' and 'Scoop' on the top line, 'Coins' on the second line, 'EUR' and '0' on the third line, and 'Total' and '0' on the bottom line.

19.01.2009	10.15
1C	Scoop
Coins	
EUR	0
Total	0

To switch Auto-Add on/off press



and



simultaneously

# Getting Started

## Switching Scroll On/Off

Auto Scroll feature allows the Cashmaster to automatically advance to the next denomination when the value has been added to the total and the money is removed from the hod.

If **Auto-Scroll is on**, once cash is removed from the hod the denomination will automatically be advanced.

If **Auto-Scroll is off**, the value displayed will not automatically advance denomination, you must manually select the next denomination required using the



keys.

*Your device may already have Auto scroll set to on/off as default. See below*

Indicates auto-scroll is on

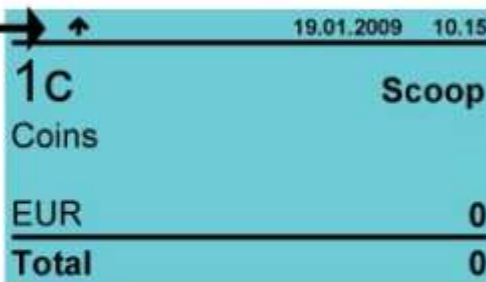

A screenshot of a Cashmaster display with a light blue background. At the top right, it shows the date '19.01.2009' and the time '10.15'. Below this, there is a horizontal line. The display shows '1C' in large font, with 'Coins' underneath it. To the right of '1C' is the word 'Scoop'. Below 'Coins' is 'EUR' and '0'. At the bottom, there is a horizontal line followed by 'Total' and '0'. An arrow points from the text 'Indicates auto-scroll is on' to the upward arrow icon at the top left of the display.

1C	Scoop
Coins	
EUR	0
Total	0

Indicates auto-scroll is off



A screenshot of a Cashmaster display with a light blue background, identical to the one above. It shows the date '19.01.2009', time '10.15', '1C', 'Coins', 'Scoop', 'EUR', '0', and 'Total', '0'. An arrow points from the text 'Indicates auto-scroll is off' to the upward arrow icon at the top left of the display.

1C	Scoop
Coins	
EUR	0
Total	0

To switch auto-scroll on/off press



and



simultaneously.



# Counting

## Counting Loose Coin

*Please ensure your Cashmaster is set to your domestic currency before continuing. See Currency Setting (page 9).*

Press the  key until the following is displayed.

☐ ↑+	19.01.2009	10.15
1C	Scoop	
Coins		
EUR		0
Total		0

Use the   keys to select the correct denomination for counting.

Place the scoop/ till cup of the selected coins on the hod; the Sigma 105 will beep and the display will show the value of the coin and the number of coins in the scoop/ till cup :

If **Auto Add is on**, The Sigma 105 will automatically update the totals, and beep to confirm the add. Remove the cup from the hod and advance to the next denomination in the sequence.

If **Auto Add is off**, leave cup on the hod and press  to add to the total, the Sigma will beep to confirm the value has been added to totals. Remove the cup from the hod and advance to the next denomination in the sequence.

*Note: If float mode is on, the float amount will decrease as more money is counted, it will be displayed at the bottom of the screen; once the float amount has been reached your Cashmaster will signal with a double beep, the screen will show the total for banking; the float has already been taken into account.*

# Counting

## Packaged Coin

Please ensure your Cashmaster is set to your domestic currency before continuing. See *Currency Setting* (page 9).

Press the  key until the following is displayed.





19.01.2009 10.15	
Rolls	
EUR	0
Total	0

Place a bag/roll of coins on the hod. If the bag/roll is full the Cashmaster recognises the weight. The denomination, together with the value, is shown on the display. *For typical package quantities see page 22.*

For certain denominations of bags the display will show:

**(2) Possible Results**



You are required to select the denomination of the bag/roll which is on your Cashmaster using  or . Press the  key to accept the value.

If the machine does not recognise the weight as a full bag/roll the following will be displayed.

\* Suspect \*

then

**Select Actual Denomination**

Using the   keys, select the actual coin denomination and the machine will then display the value together with the number of coins in the bag/roll.

Press the  key to accept the value and add to the grand total.





# Counting

## Learning - Notes Only

Press the  key to select note mode.

All Cashmaster machines are calibrated at our production facility to the average note weights of your domestic currency. As note weights vary slightly depending on age and usage and humidity of the environment, the following should be completed on receipt of your new machine.

*(Please ensure Auto Add/Scroll has been switched off before beginning "Learning" see page 11 and 12.)*

1. Press  or  until you reach the note denomination required.
2. Place 8 -10 notes of the chosen denomination on the hod.
3. When the Sigma 105 beeps add some more notes.
4. Remove all notes from the hod.
5. Repeat steps 2 - 4 several times each time increasing the number you apply in one slice. After repeating a few times you will be able to apply 25 - 30 notes in one go.

If the display shows :



remove a few until you see a valid reading, then continue.

# Counting



## Counting Loose Notes

*Please ensure your Cashmaster is set to your domestic currency before continuing. See Currency Setting (page 9).*

Press the  key until the following is displayed.



☐ ↑+	19.01.2009	10.15
<b>€5</b>		
Notes		
EUR		0
<b>Total</b>		<b>0</b>

Use the   keys to select the correct denomination for counting.

Place notes of the selected denomination on the hod.

Notes should be applied in slices of up to 30 notes at a time. The device is constantly learning, if too many notes are applied this message will be displayed.



**Too many  
Remove Some**

Simply remove a few notes until the message disappears, then continue adding notes to those already on the hod.

Repeat above steps for each denomination of note. To skip a denomination,

press  or .

# Totalling, Clearing & Printing



## Adding

To add a value, currently on the display, to the total press the  key.

## Auto Adding/Scrolling

For auto adding and auto scrolling see page 11 and 12.

## Clearing the Sub-Totals

Select the denomination to be cleared by using  and  keys then press the  key.

## Clearing Totals

Press and hold the  key until screen prompt shows "Press C key again to confirm".

To clear the totals now press the  key again. To cancel clearing press any other key.

## Printing

Providing a printer is connected, print the totals by pressing the  key.

*Note: When using the printer it is always advisable to operate the machine with the mains adapter connected.*

# Grams Mode

---

## Grams Mode

Grams Mode can be used to :

1. Weigh and/or directly compare bundles of notes.
2. Check that the scale is weighing correctly by applying a weight known to be accurate.
3. Weigh letters to determine postal rates.

### To enter Grams Mode :

Press  and  at the same time.

The display will show :



If the Cashmaster drifts from 0.0g when the hod is empty, press  to reset scale to zero.

### To exit Grams Mode and return to normal operation :

Press  and  at the same time.

*NOTE: The maximum weight the Cashmaster can weigh is approximately 1.5kg. Do not put any weight above this on the Cashmaster.*

# Troubleshooting

Mode	Message	Description
<b>Coins</b>		
Loose/ packaged	Too much weight on scale	This means there is too much weight on scale, simply remove some. The Cashmaster will weigh up to a maximum of 1.5kg.
Roll Verify	* Suspect *	Roll applied is suspect. User may leave roll on hod and select the correct denomination for an actual roll amount.
<b>Notes</b>		
Loose note counting	PRESS ZERO KEY	Cashmaster has drifted from zero (usually due to draught or vibration). Ensure the hod is empty, then press on/off key momentarily.
Loose note counting	Please remove scoop/till cup from scale	Please remove scoop/till cup from the scale User has selected a note denomination while the cup is still on the hod. Remove the scoop/till cup.
Loose note counting	Too many Remove some	Notes should be applied in amounts of up to 30 at a time. Simply remove a few notes until the message disappears then continue counting.
<b>Misc</b>		
	High vibration lockout	Check that the Cashmaster is placed on a level surface and away from vibrations and draughts (e.g. air conditioning or fan).
	Battery low	Plug machine into power supply to recharge battery.
	Print timeout	Ensure that printer is switched on and properly connected to the scale before retrying.
	Scale is below minimum weight!	Indicates that the hod has not been placed correctly. Ensure hod is pushed firmly into the Cashmaster.



## How do I clear sub totals?

Select the desired denomination and press  key momentarily.

## How do I clear grand total?

From the count screen hold down the  key until the confirmation is displayed. Press the  key again to confirm and clear.



## How do I switch currencies?

Press both   keys simultaneously to scroll through multicurrency options, stopping at the desired currency.

## How do I access/leave Grams Mode?

Press simultaneously the  key and the  key.

## How do I update the firmware?

1. Ensure that the machine is turned off.
2. Remove cover located to the left underneath the machine.
3. Insert the SD card in slot marked "SD-CARD".
4. Connect the machine to the power adapter.
5. Press and hold down the  key for approximately 10 seconds
6. The serial number will be displayed.
7. Press the   keys simultaneously and the update will commence, please allow up to 2 minutes for prompt to remove the SD card.
8. Remove the SD card.

## **The SUSPECT BAG / ROLL message displayed**

Bag or roll applied has a suspect weight – select the correct denomination by using the arrow keys.

## **What is the maximum weight the machine can weigh?**

Approximately 1.5kg.

## **What do I do if my printer does not work?**

1. Ensure printer is connected to machine
2. Ensure printer has power
3. Ensure printer is loaded with paper
4. Ensure paper grip lever is in downward position

## **What are the typical “full” package quantities for my currency?**

Please see Typical Quantity Guide.

**For all other problems or issues contact our Customer Support team on:  
01383 410 121 or 01383 416 098.**

# Technical Specification

## Cashmaster Sigma 105 Specification

Weight	1kg
Dimension	162mm (W) x 172mm (H) x 224mm (D)
Load Capacity	1.5kg
Power Supply	Mains adapter 12V 2.5A
LED red:	Battery charging
LED Green:	Battery fully charged
LED flashing red/green:	Very low battery and charging
LED off:	Power from battery only
Battery Type	LiPo 7.4V 1250mAh



Customer Support - 01383 410 121  
UK Head office - 01383 416 098



support@cashmaster.com  
www.cashmaster.com



Cashmaster International  
Innovation Buildings  
Fairykirk Road  
Rosyth  
Fife  
KY11 2QQ

For all Customer Support/Warranty issues please contact our Customer Support team on 01383 410 121 or 01383 416 098.



# Declaration of Conformity

## EC Declaration of Conformity

Cashmaster Sigma models manufactured in Scotland, Rosyth are in conformity with the provisions of the following European Directives:

**89/336 and 93/68/EEC** Electromagnetic Compatibility Directive  
**73/23 and 93/68 /EEC** Low Voltage Directive

## FCC Compliance Statement

This equipment has been tested and found to comply with the limits for a Class B digital device, pursuant to Part 15 of the FCC Rules. These limits are designed to provide reasonable protection against harmful interference in a residential installation. This equipment generates, uses and can radiate radio frequency energy and, if not installed and used in accordance with the instructions, may cause harmful interference to radio communications. However, there is no guarantee that interference will not occur in a particular installation. If this equipment does cause harmful interference to radio or television reception, which can be determined by turning the equipment off and on, the user is encouraged to try to correct the interference by one or more of the following measures:

- Reorient or relocate the receiving antenna.
- Increase the separation between the equipment and receiver.
- Connect the equipment into an outlet on a circuit different from the one which the receiver is connected to.
- Consult the dealer or an experienced radio/TV technician for help.

You are cautioned that changes or modifications not expressly approved by the party responsible for compliance could void your authority to operate the equipment.

## Approvals



Complies to  
EU Directive,  
2002/95/EC

RoHS  
2002/95/EC

Complies with  
EU Directive  
2002/96/EC  
on the restriction  
of hazardous  
substance  
in electrical  
& electronic  
equipment

Signed for Cashmaster Ltd



Douglas Reid  
Engineering Director



Bill Hamilton  
Technical Director